

ACTIVE VIBRATION ISOLATION

System *TS 300*

Instruction manual



Address:
Fabrik am Weiher
CH-8909 Zwillikon
Switzerland

Phone: +41 44 776 33 66
Fax: +41 44 776 33 65
E-Mail: info@tablestable.biz
Internet: www.tablestable.biz



Table of Contents

Notes on Equipment Safety.....	3
Safety Instructions.....	3
Accessories.....	3
General.....	4
Optimum Support Surface.....	5
Test of Support Surface.....	5
First Time Installation.....	5
Auto-Levelling.....	5
Adjustable Foot.....	6
Operation.....	6
Display Overview.....	7
Observing Mode.....	8
Function Menu.....	8
Locking System for Transport.....	9
Isolation Mode.....	9
BNC Output Jack.....	9
Remote Output.....	9
Specifications TS-300/TS300LT.....	10
Transmissibility.....	11

Sales Offices

Geographical Europe, near and middle East, Africa, India:	Americas, Australia, New Zealand:	Asia:
Georgstrasse 11, 72119 Ammerbuch, Germany Phone: +49-7073-916-796 Fax: +49-7073-916-798 e-mail: hw1@hw1scientific.com Internet: www.hw1scientific.com	23151 Alcalde Dr. Unit B-3 Laguna Hills, Ca 92653 USA Phone: 949-363-2905 Fax: 949-340-9751 e-mail: sales@herzan.com Internet: www.herzan.com	18/F., Yokohama Creation Square Bldg.,5-1, Sakaecho, Kanagawa-Ku Yokohama Kanagawa 221-0052 Japan Phone: +81-45-450-2211 Fax: +81-45-450-2221 e-mail: sales@herz-f.co.jp Internet: www.herz-f.co.jp

Notes on Equipment Safety

The vibration isolation system **TS-300** has been designed, manufactured and tested to conform to the safety regulations for measurement- and control-equipment DIN EN 61010-1:2001 (IEC 61010-1 second edition 2001-02) and satisfies the relevant requirements of EEC Directive 73/23. The system conforms to EEC Directive 89/336 (electro-magnetic compatibility). The operator should read this manual which contains important warnings and information.

Safety Instructions

- The system may only be plugged into a socket with separate ground. Do not disconnect this ground, either at the socket, or by using an ungrounded extension cable.
- Before switching on this apparatus make sure that it is connected to the correct mains voltage.
- Do not remove any cover or allow any metal objects to enter any openings in the unit.
- Disconnect from mains before removing any covers. Refer servicing to qualified personnel.
- Do not use in potentially explosive surroundings.
- Do not drill any holes into the top plate. This will damage the system.
- The fuses are located in the rear panel power socket. Do not attempt to change a fuse without first unplugging the power cable. Only replace a fuse with the correct type. Never try to bypass a fuse.

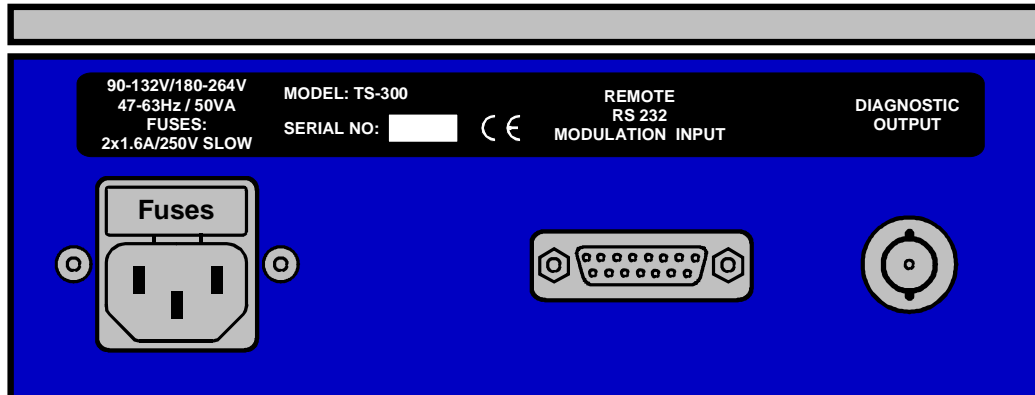

- If you suspect the system to be in any way unsafe, unplug and prevent any possible accidental usage. Contact your nearest service centre.

Accessories

- 1 Power Cable
- 1 Manual
- 1 Remote Control Box (optional)



General

The **TS-300** is a compact dynamic antivibration system, which is offering isolation against all six translational and rotational vibration modes.

This moderately priced dynamic vibration isolation system achieves in a very small volume better isolation than is possible with the biggest and most expensive passive systems. Inertial feedback is used via electromagnetic transducers to provide not only isolation from building vibrations, but also isolation from vibration sources placed on the system itself. This means, for example, that a delicate microscope isolated by the system will remain at rest despite forces being applied via the operator's hands.

The inherent stiffness of the system, typically 25 times greater than that of a 1 Hz resonance passive isolator, imparts excellent directional and positional stability.

The characteristics of an active isolation system are typified by the virtual lack of any low frequency resonance, a resonance which plagues all passive isolation systems.

The **TS-300** is a complete active isolation system measuring 600 x 800 x 120 mm. The system isolates against all six possible translational and rotational vibration modes and has been designed to offer excellent isolation even at frequencies as low as 2-3Hz, where many buildings show large horizontal amplitudes due to oscillation about the vertical axis.

This system is extremely convenient to use. Load compensation (auto-levelling) is performed automatically on switching on the power. If the load is changed whilst the system is isolating, it automatically readjusts and then returns to the isolation mode. Furthermore, at the push of a button the system locks itself for shipping. Apart from a single adjustable foot to allow for unevenness in the support surface, there are no manual adjustments to be made.

All the control circuitry, including the power supply, is built into the unit. Typically power consumption is less than 10 W, rising to 40 W in extreme environments. The unit has an universal input and may be connected to any AC power point between 115 and 230 V \pm 10%.

The system is intended for use as a standard stable table for loads up to 300 Kg (TS-300LT 120kg). The design has been optimized to achieve best possible isolation for delicate instruments such as the Scanning Probe Microscopes (AFM, STM), Scanning Electron Microscopes, Interferometers and other high resolution instruments, allowing the ultimate performance to be achieved from these instruments. The tables have also proved to be extremely successful for supporting sensitive experiments, such as patch clamp, micro injection or the troughs for liquids used in measurements on Langmuir-Blodgett films.

Isolation of the **TS-300** system begins at about 0.7 Hz, increasing rapidly to at least 40dB beyond 10 Hz. This system offers excellent isolation in the typical laboratory environment.



Optimum Support Surface

To obtain the optimum performance from the system it must be supported on a surface which is as rigid as possible. The best possible performance is obtained with the **TS-300** sitting directly on the floor. However for most applications this will not be practical, and some support structure will be required to bring the system to a convenient operating height. Most simple table structures will be rigid enough vertically, but will leave much to be desired horizontally. The addition of diagonal struts between the table legs can improve the situation dramatically.

It is good to bear in mind that any support structure will follow the building vibrations exactly up to some certain cut off frequency at which point the structure goes into resonance and amplifies the vibration amplitudes. A typical structure may have its lowest horizontal resonance frequencies around 40-60 Hz.

It is an unfortunate fact of life that the amplitudes of the vertical vibrations of the building (dominantly bending modes of the floor) are largest in the centre of the floor, where for convenience most experiments are situated!

Since the table **TS-300** is quite small a possible location may be on a shelf attached to a building pillar. Good braces will be required to support the shelf. This location has the advantage that the vertical vibrations of the building will be very much reduced.

Test of Support Surface

The best location for the system is directly on the floor. This is generally rather inconvenient and a support structure is used to bring the system to a suitable working height. Although the **TS-300** will operate on any support surface, a soft support structure resonantly amplifies certain building vibration frequencies and these will therefore be less effectively isolated.

You can obtain an idea for the suitability of your support structure by observing the above diagnostic signal while pushing on the support. The isolation should be disabled for this test. If the support is rigid the signals should hardly respond to a push on the support in any direction. Now try tapping the support to excite its internal resonances. Generally the support will react more strongly to a horizontal tap than to a vertical one. A very resonant support will show long lived resonances and the isolation will be seriously affected at these frequencies. A better support will show well damped resonances.

First Time Installation

For shipping the system has been locked to prevent damage. It will automatically be unlocked when power is applied to the system. Sometimes equipment can get very cold during shipping. We recommend that if the system is cold you allow 2-3 hours for it to reach room temperature before connecting the power, otherwise a malfunction may arise due to condensation.

Auto-Levelling

When operating the system for the first time, place on a suitable rigid support surface and switch on the power. If the system has been locked for transport the motors will run rapidly for a few seconds until the system is floating.

Adjustable Foot

Important: make sure that the system is unlocked before adjusting the foot

Before proceeding further check first that the system is sitting properly on the support surface. The rear right foot is adjustable – turn until the system is sitting well balanced on all four feet.

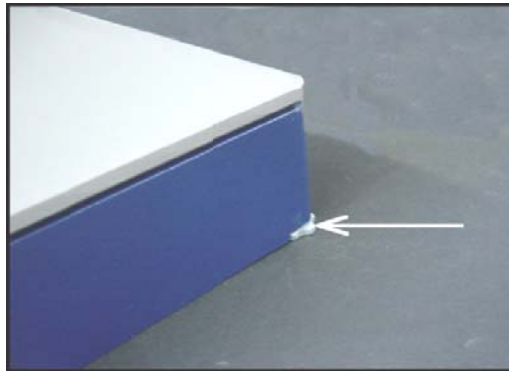

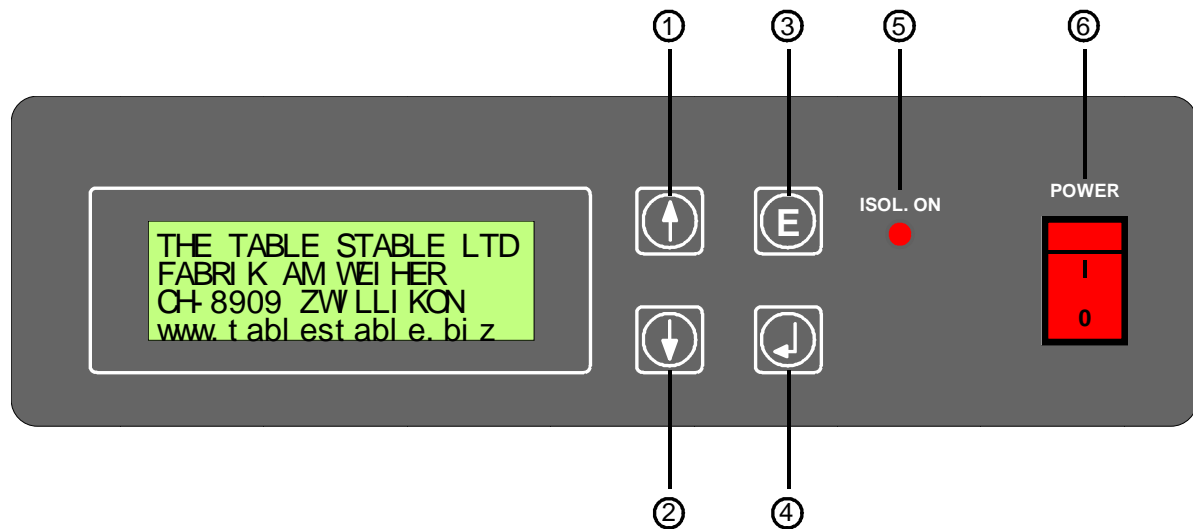

Operation



- 1 Scroll Up
- 2 Scroll Down
- 3 Enable / Disable Isolation
- 4 Enter
- 5 Isolation Indicator
- 6 Power Switch

Display Overview

Push  or  to toggle between display pages:

System is setting the correct height.

System is unable to set the correct height. The load may be badly distributed.

Isolation off, push  to activate isolation.

System is Isolating, push  to deactivate isolation.

Push  to lock the system for transport.
System will automatically unlock when the power is switched on.

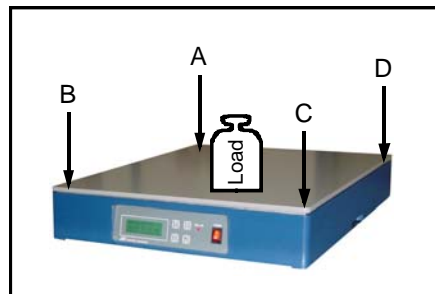

Weight shows the load on each corner. A flashing bar means an overload or bad load distribution, the system will not isolate.

Balance shows the centre of the height adjustment. Under normal circumstances the bars should be approximately in the middle. A flashing bar means the system is not balanced and will not isolate.



Observing Mode

Time Base (0-4)

The traces show velocity, but are not calibrated – the top trace is vertical and the lower 2 traces show the horizontal vibrations. H1 is parallel to the cables attached to the unit, and H2 perpendicular to this axis. The time axis can be changed by pushing the Enter button.

A higher index number N gives a slower display.

The approximate time per scan is 160×2^N milliseconds.

Note: This function is not intended for measurement purposes and is not calibrated.

On using the system for the first time it is strongly recommended that you observe this signal, with the isolation both Enabled and Off - it gives a good impression of how well the system is operating.

Function Menu

Push  to gain access to the function menu.

The backlight may be turned off if desired. Scroll display to the appropriate function and push  to toggle between backlight on and off.

Power-on Isolation enable

If this function is on, the isolation will start automatically after the system is switched on. This function is useful when a remote control-box is connected on the rear (Optional).

Push  to exit the function menu without saving the changes. When you switch the system off, all settings will be lost.

Push  to exit the function menu and save all the settings. All settings will be present after switching the system off.

Locking System for Transport

In order to prevent damage during shipping it is essential to lock the system. With the system switched on, scroll the display until the message "to lock push ↓" appears. Push ↓ and the motors will run, gradually slow down and then stop. The message "system locked" will appear.
Switch off.
The next time the system is powered up it will automatically unlock.

Isolation Mode

After switching on the power, and once the motors have stopped running, the table top will be floating and the display will show "Isolation Disabled". To enable the isolation merely push the button marked E. The system is now operating and the red LED will light up.

BNC Output Jack

The rear panel BNC socket gives a multiplexed output showing the signals from all 8 accelerometers.

To view this signal on an oscilloscope, set the time base to **20msec** and the sensitivity to **1V**.

The signals are for diagnostic purposes only and do not correspond to horizontal and vertical axes.

Remote Output

A remote control box (optional) can be connected to the D-Sub socket and allows you to switch the Isolation on and off externally.





Specifications TS-300/TS300LT

Isolation:	dynamic 0.7Hz to 1kHz, purely passive beyond 1kHz.
Transmissibility:	see attached curve. Above 10 Hz transmissibility <0.01 (-40dB)
Correction Forces:	Maximum $\pm 4N$ in any direction.
System Noise:	less than $20nG/\sqrt{Hz}$ from 0.1-200Hz in any direction
Maximum Load:	TS-300 : 300 kg TS-300LT: 120 kg
Static Compliance:	approx. $12\mu m/N$ vertical approx. $30-40\mu m/N$ horizontal
Size:	600x800x120 mm
Weight:	53 kg

Electrical

Safety class:	1
Power Consumption:	typically 10 W, maximum 50 W (70 VA)
Input Voltage:	115 – 230 V AC $\pm 10\%$, 50 – 60 Hz
Fuses:	2 x 1.6A/250V slow, located in the power socket on the rear side of the unit.

Normal Environmental Conditions

Protection class:	IP 20
Temperature range:	5°C - 40°C
Relative humidity:	10 – 90% (5 – 30°C) 10 – 60% (30 – 40°C)
Application:	Indoor
Altitude:	up to 2000m (6500ft)

Table Top

Size:	600x800 mm
Material:	Damped aluminium sandwich construction 3.5cm thick Also available with tapped M6 on 25mm centres.



Transmissibility

