

# ***ACTIVE VIBRATION ISOLATION System*** ***AVI-600/LP***

## ***Instruction Manual***

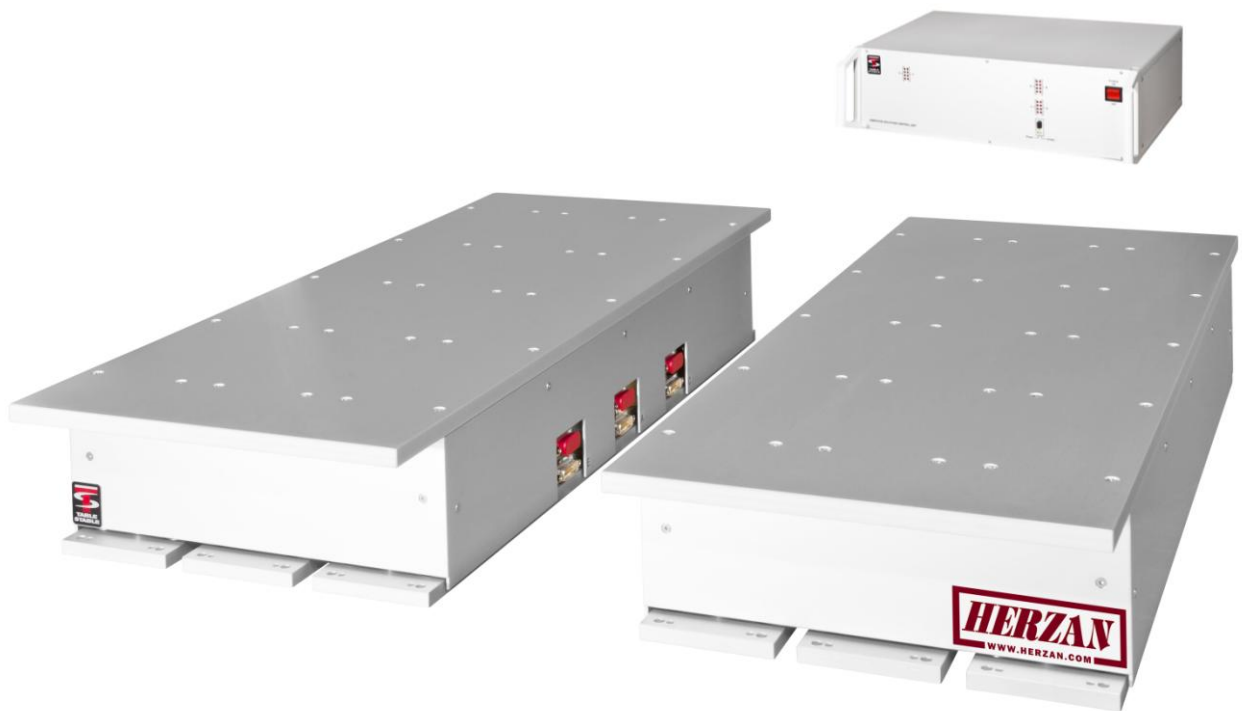

### MANUFACTURER



Address:  
Fabrik am Weiher  
CH-8909 Zwillikon  
Switzerland

Phone: +41 44 776 33 66  
Fax: +41 44 776 33 65  
E-Mail: [info@tablestable.biz](mailto:info@tablestable.biz)  
Internet: [www.tablestable.biz](http://www.tablestable.biz)



## Table of Contents

<i>Safety Instructions</i> .....	3
<i>Accessories</i> .....	3
<i>General</i> .....	4
<i>AVI-600/LP Control Unit</i> .....	5
<i>Optimum Support Surface</i> .....	6
<i>Choice of Table Top</i> .....	6
<i>Attaching Table Top</i> .....	6
<i>Adjustment for Change of Load</i> .....	7
<i>Operation</i> .....	9
<i>Test of Support Surface</i> .....	9
<i>BNC Output Jack (Diagnostic Signal)</i> .....	10
<i>Pin layout on the rear remote D-Sub 15 socket for AVI-Systems</i> .....	11
<i>Installation Checklist</i> .....	12
<i>Troubleshooting</i> .....	13
<i>Specifications AVI-600/LP</i> .....	14
<i>Transmissibility</i> .....	15
<i>Dimension AVI-600/LP</i> .....	16



## **Safety Instructions**

The system may only be plugged into a socket with separate ground. Do not disconnect this ground, either at the socket, or by using an ungrounded extension cable.

If you suspect the system to be in any way unsafe, unplug and prevent any possible accidental usage. Contact your nearest service centre.

Before switching on this apparatus make sure that it is connected to the correct mains voltage. Do not remove any cover or allow any metal objects to enter the ventilation slits.

Disconnect from mains before removing any covers. Refer servicing to qualified personnel.

Do not use in potentially explosive surroundings.

The fuses are located in the power socket on the rear side of the control unit. Do not attempt to change a fuse without first unplugging from the mains. Only replace a fuse with the correct type. Never try to bypass a fuse.

Make sure the ventilation slits in the control unit are not covered and that air can freely circulate. Blocking the slits can lead to overheating which could cause a fire.

For connection between the control unit and the isolation elements use only the D-Sub 15 cable (m/f) provided.

## **Notes on equipment safety**

The vibration isolation system AVI-600/LP has been designed, manufactured and tested to conform to the safety regulations for measurement- and control-equipment DIN EN 61010-1 (IEC 1010-1) and satisfies the relevant requirements of EEC Directive 73/23. The system conforms to EEC Directive 89/336 (electro-magnetic compatibility). The operator should read this manual which contains important warnings and information.

## **Cleaning the outside of the System**

Use neutral detergents. Cleaning with solvents will damage the outside surface of the system. DO NOT use cleaning materials that contain ammonia. DO NOT use isopropyl alcohol to remove dirt from the control panel. It may crack the panel. DO NOT use flammable substances or any type of spray to clean the system.

## **Accessories**

1 Hex Key 2mm  
1 Spanner 10mm  
1 Power Cable  
6 D-Sub 15 Cables 5m  
1 Instruction Manual

## General

This moderately priced dynamic vibration isolation system achieves in a very small volume better isolation than is possible with the biggest and most expensive passive systems. Inertial feedback is used via force transducers to provide not only isolation from building vibrations, but also isolation from vibration sources placed on the system itself. This means, for example, that a delicate microscope isolated by the system will remain at rest despite forces being applied via the operator's hands.

The inherent stiffness of the system, typically 500 times greater than that of a 1 Hz resonance passive isolator, imparts excellent directional and positional stability.

The lack of any low frequency resonance, a resonance which plagues all passive systems, allows the systems to be stacked for super-isolation in severe environments.



AVI-600/LP is an adaptable system consisting of two modules and is ideal for supporting delicate Fabry-Perot interferometers and tunnel-microscopes, allowing the ultimate performance to be achieved from these and other high resolution instruments. The tables have also proved to be extremely successful for supporting sensitive experiments, such as the troughs for liquids used in measurements on Langmuir-Blodgett films.

Each module by itself isolates against vertical and horizontal translations and against rotations about one horizontal axis. The combination of two modules isolates against all six possible translational and rotational vibrations. The modules cannot be used separately.

Isolation of the standard AVI-600/LP system begins at about 2Hz, increasing rapidly to at least 35dB beyond 10Hz. This system offers excellent isolation in the typical laboratory environment.

## AVI-600/LP Control Unit

The control unit provides the power for driving the modules. Typically power consumption is less than 22W, rising to 28W in extreme environments. The control unit has an input which may be connected to any AC power point of 110 or 230V  $\pm 10\%$ .

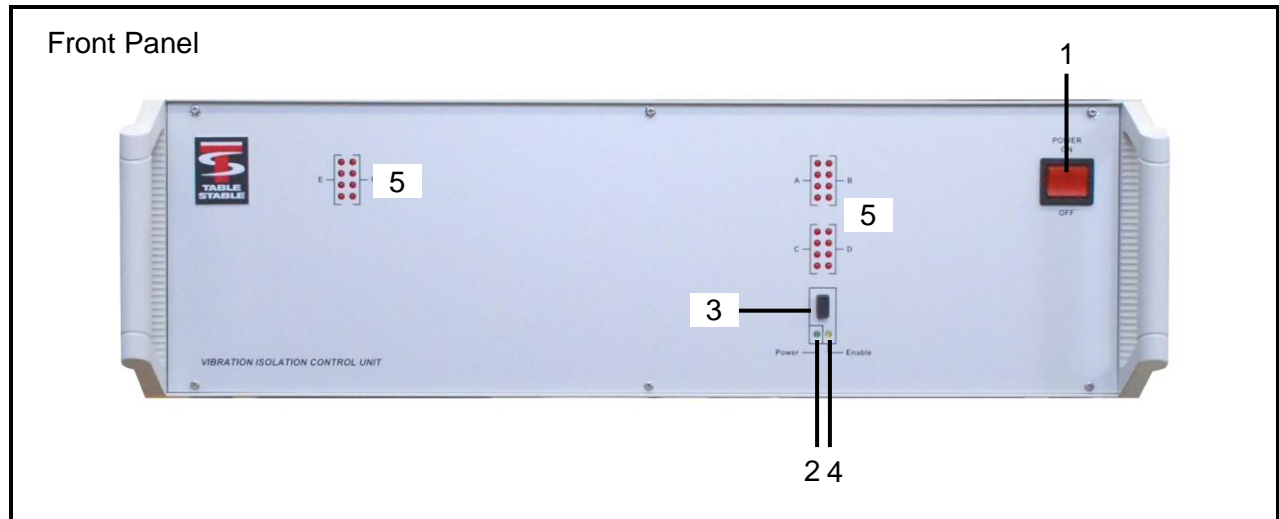

- |                   |                              |                                   |
|-------------------|------------------------------|-----------------------------------|
| 1 Power switch    | 3 Isolation enable switch    | 5 Output stage overload Indicator |
| 2 Power indicator | 4 Isolation enable indicator |                                   |

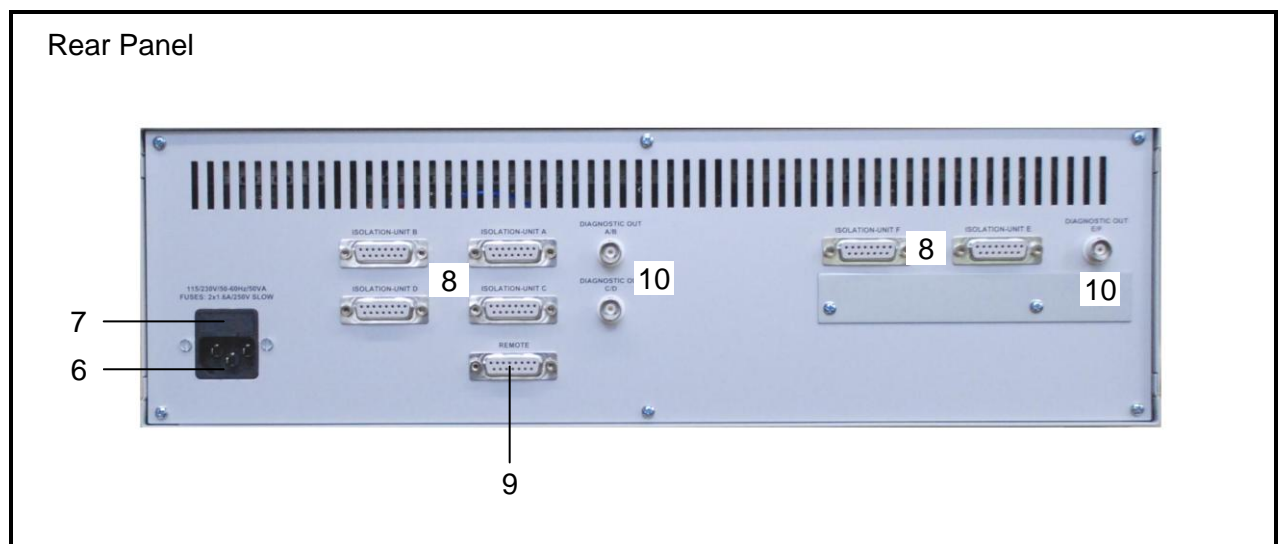

- |                |                          |                      |
|----------------|--------------------------|----------------------|
| 6 Power socket | 8 Isolation unit sockets | 10 Diagnostic output |
| 7 Fuses        | 9 Remote socket          |                      |



## **Optimum Support Surface**

To obtain the optimum performance from the system it must be supported on a surface which is as rigid as possible. The best possible is to put AVI-600/LP directly on the floor. However for most applications this will not be practical, and some support structure will be required to bring the system to a convenient operating height. Most simple table structures will be rigid enough vertically, but will leave much to be desired horizontally. The addition of diagonal struts between the table legs can improve the situation dramatically.

It is good to bear in mind that any support structure will follow the building vibrations exactly up to some certain cut off frequency at which point the structure goes into resonance and amplifies the vibration amplitudes. A good structure will have its lowest resonance frequency well above 100Hz.

It is an unfortunate fact of life that the amplitudes of the vertical vibrations of the building (dominantly bending modes of the floor) are largest in the centre of the floor, where for convenience most experiments are situated!

Since the table AVI-600/LP is quite small a possible location may be on a shelf attached to a building pillar. Good braces will be required to support the shelf. This location has the advantage that the vertical vibrations of the building will be very much reduced.

## **Choice of Table Top**

The table top must be sufficiently stiff to prevent a relative rotation of the two isolation units about their long horizontal axes. A honeycomb breadboard or an aluminium plate 30mm thick will give best results, but stone plates or even solid wooden boards may be used. For the positions of the attachment holes, see the drilling plan at the end of this document.

Note that it is also possible to attach the isolation units directly to the supported equipment. In this case a rigid mounting is absolutely essential. We will be happy to advise you on the best mounting method.

## **Attaching Table Top**

Lower the table top gently into position and slide until the attachment holes in the table top align with the holes in the isolation units. Attach each unit securely with 6 M5 bolts. These bolts should not extend by more than 10mm below the lower surface of the table top.

**Do not under any circumstances be tempted merely to rest the table top on the isolation units. This is guaranteed to give poor results.**

It may happen that it is inconvenient to put bolts through the table top. In this case it is admissible to use an intermediate plate between units and table top. The intermediate plate should be at least 5mm thick and must be attached in the usual manner to the isolation units. The table top is then attached by screwing upwards through the intermediate plate into the lower surface of the top plate.

**If you use this option please note that it is absolutely essential to place grease between the intermediate plate and the table top - failure to do so may result in oscillations between these two plates which will prevent the system from operating.**

## Adjustment for Change of Load

Each unit of AVI-600/LP can be adjusted to accommodate loads in the range 0 to 600kg. For any setting the load on the system consisting of two units, may be varied +/- 90Kg without having to reset the adjustments.

Fig.1

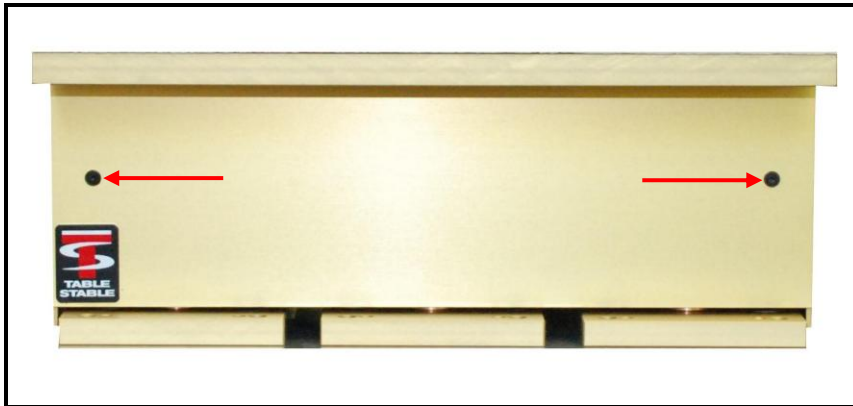

To expose the adjustment nuts, remove the end covers by undoing the screws shown in Fig. 1 (2mm hex key).

Fig. 2

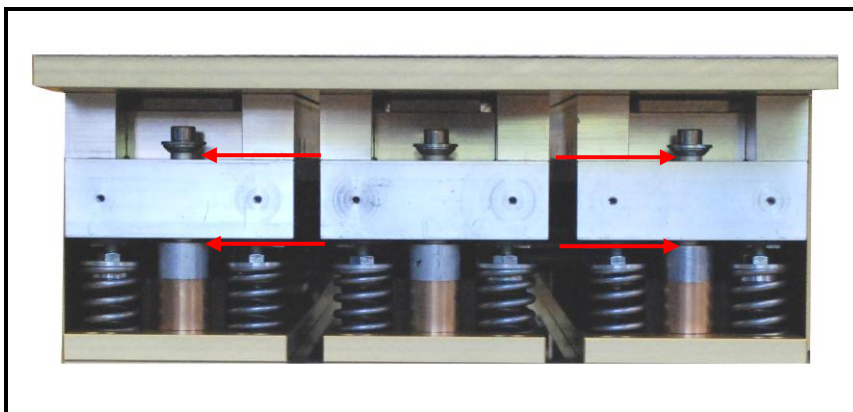

Under load the upper gap and the lower gap shown in Fig. 2 should be approximately equal. (It is however not essential that the gaps be equal - either gap may be as small as 0.5mm without affecting normal operation, but a small subsequent change of load might cause the unit to move against the stop).

Fig. 3

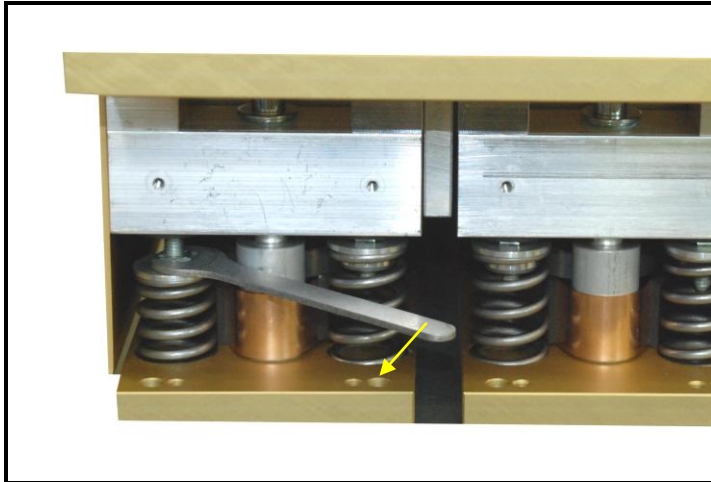

If an adjustment is needed turn the M6 nuts using the spanner provided. Adjust all springs on both sides equally. Moving the spanner to the left raises the units.

Fig. 4

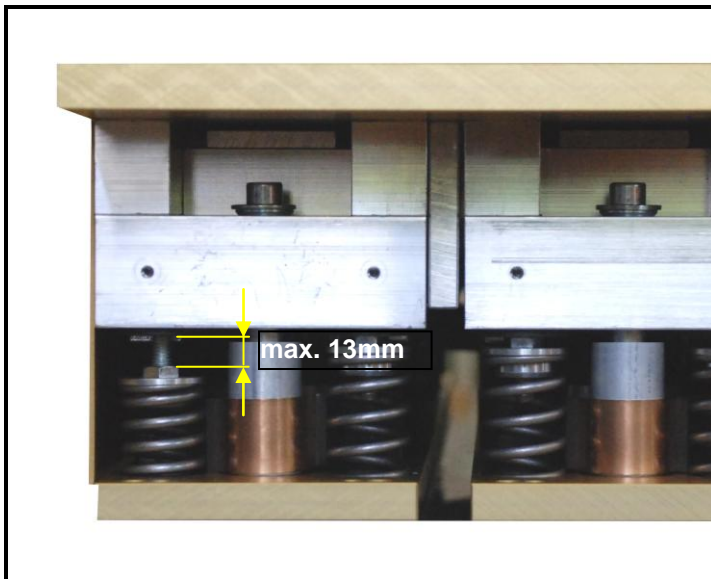

Do not turn the nuts too far or you may damage the units. Under no circumstances should the gap indicated in Fig. 4 be greater than 13mm.





## Operation

When operating the system for the first time, set the front panel isolation switch to OFF (black knob out). Switch on the power. The power indicator lamp will now light and the 24 display LEDs will briefly flicker. The yellow enable LED will flash on and off at about 2 Hz. If severe vibrations are present or if you place your hand on the table top, some or all of the LEDs will flicker.

About 30 seconds after switching on the power, you may push the isolation switch to ON position (red knob in). **The yellow LED will now stay permanently on, indicating that the system is isolating.**

Place a hand gently on the table top. Probably one or more LEDs in the upper block will come on, indicating an overload. Learn how much force may be applied without causing an overload. If you now apply a lot of force to the table top, all overload lamps will come on and the **isolation indicator lamp will flash** for a few seconds, indicating that the system is temporarily no longer isolating until the overload is removed (**standby mode**).

After removing the overload, the isolation lamp should come on again, and the system begins to isolate. Some overload LEDs may come on and persist for a few seconds. Even during this stage the system is isolating - but at reduced gain. After a severe overload the system may take half a minute to reach full isolation, but normally only a few seconds is required.

**NOTE:** In normal use the isolation switch may be left in the ON position (black knob in). On switching on the power, the yellow lamp will at first flash, indicating the system is in the standby mode. After about 30 seconds the lamp stops flashing and stays on, indicating that the system is now isolating.

## Test of Support Surface

With the system operating, push on the support surface. The lamps should not light up except possibly for a severe push. If the lamps can easily be made to light up, then the support surface is not sufficiently rigid to obtain full performance. Ascertain whether the support surface reacts more to horizontal or vertical forces and try to stiffen the structure appropriately.

**Note that the system will operate on any support surface, but a soft structure resonantly amplifies certain building vibration frequencies and these will therefore be less effectively isolated.**

## BNC Output Jack (Diagnostic Signal)

The rear panel BNC sockets give a multiplexed output showing the signals from all 24 accelerometers. To view this signal on an oscilloscope, set the time base to 20msec and the sensitivity to 1V.

On using the system for the first time it is strongly recommended that you observe this signal, with the isolation switch both ON and OFF - it gives a good impression of how well the system is operating.

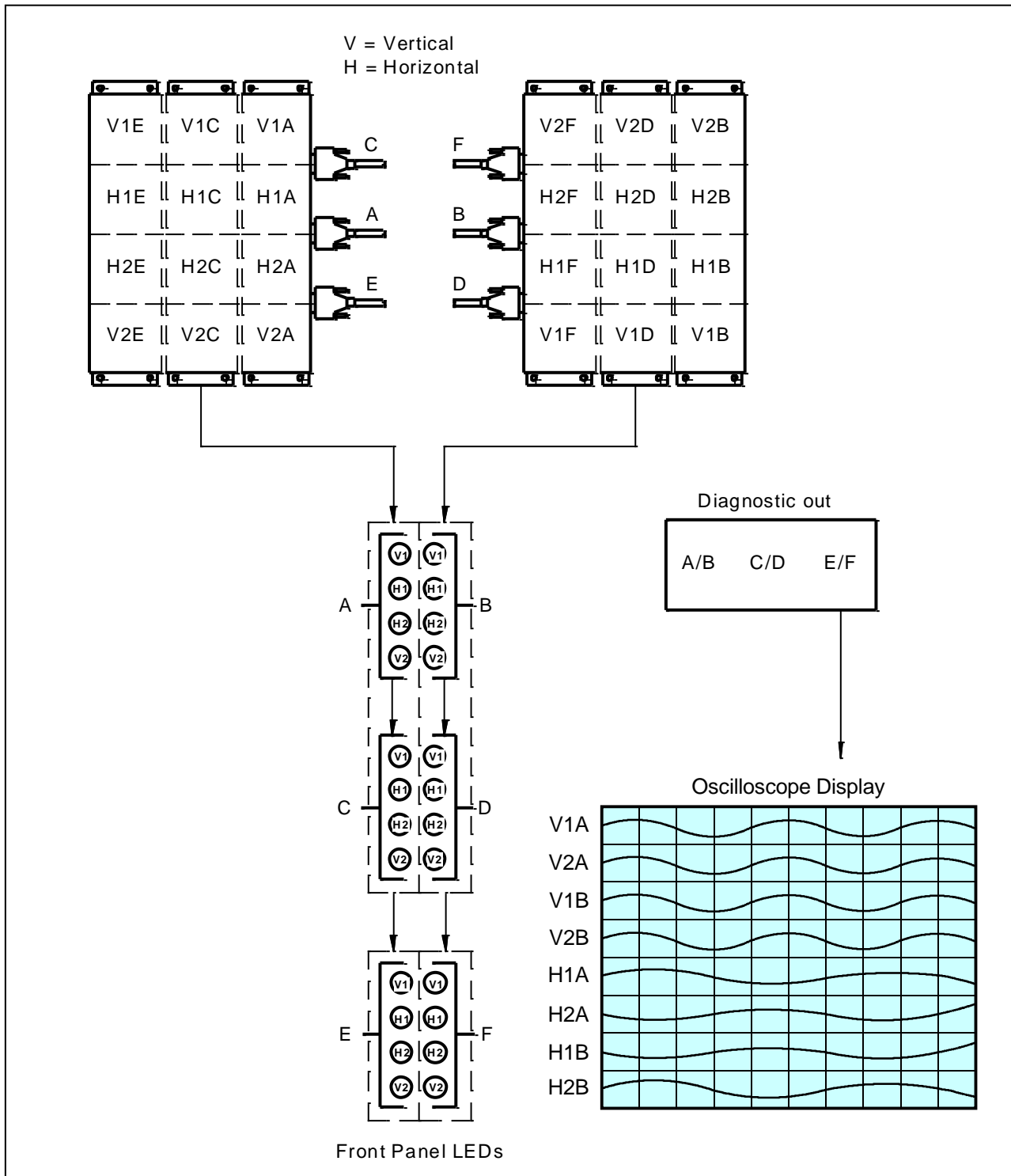

## Pin layout on the rear remote D-Sub 15 socket for AVI-Systems

### REMOTE

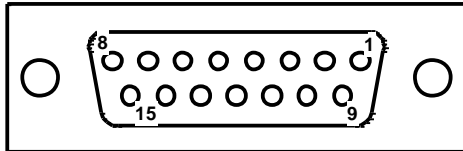

- 1
- 2 (RXD)
- 3 (TXD)
- 4 -8V
- 5 GND
- 6
- 7
- 8
- 9 +8V
- 10 ext. disable
- 11 ext. disable Indicator
- 12
- 13
- 14
- 15

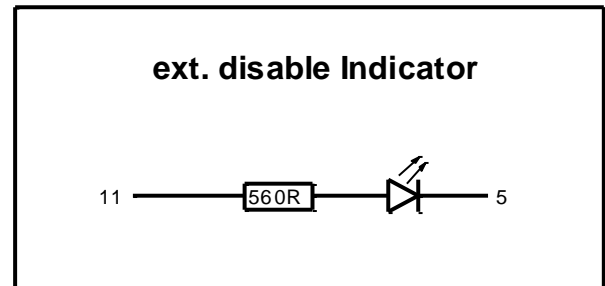
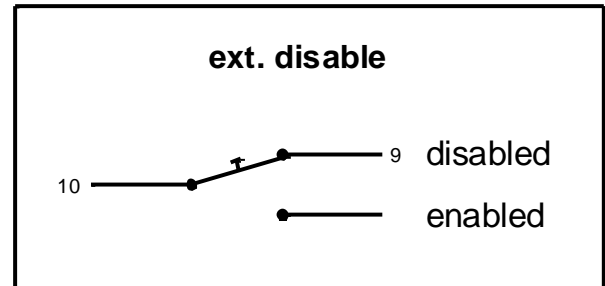



## Installation Checklist

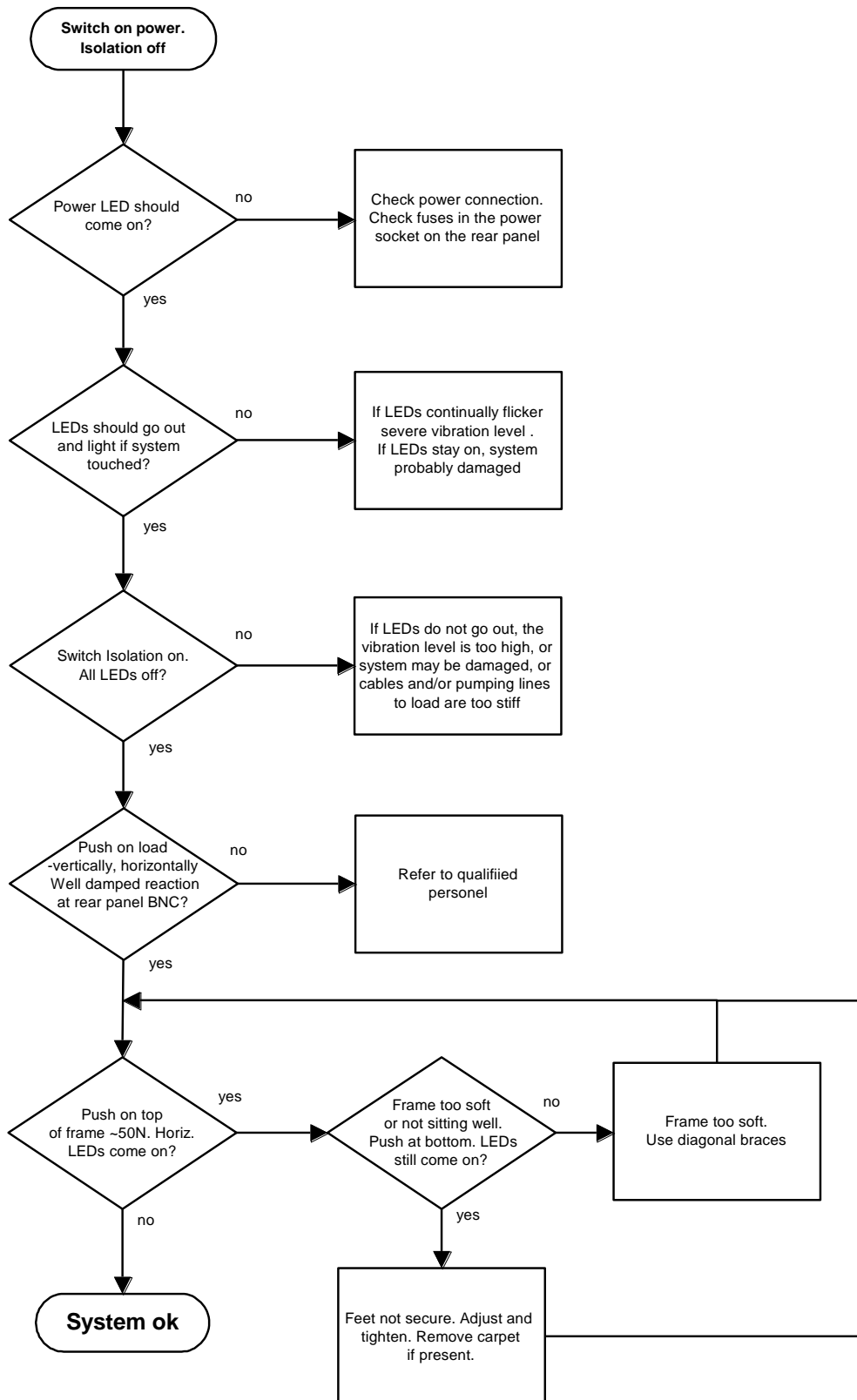

## Troubleshooting

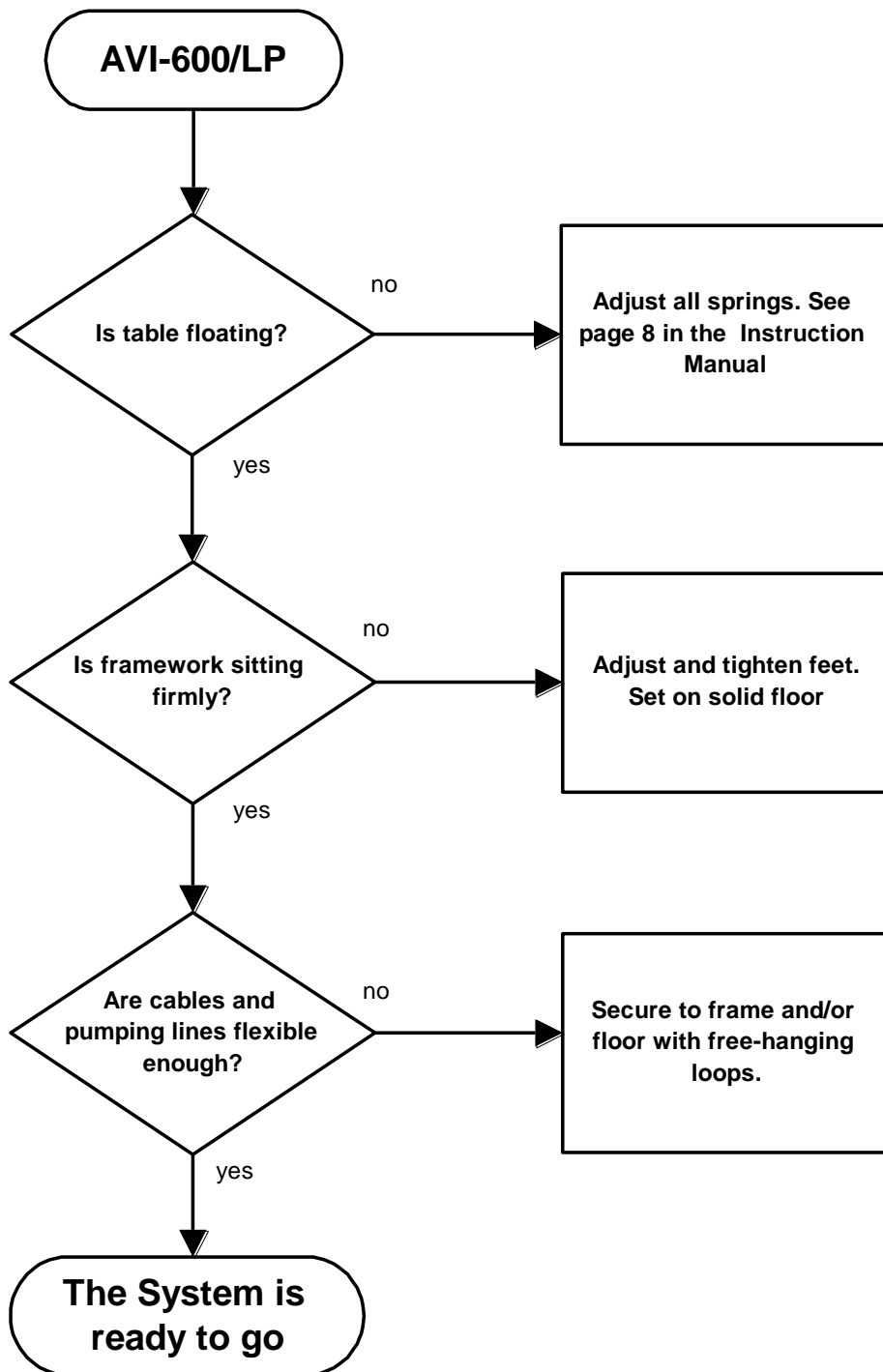



## Specifications AVI-600/LP

AVI-600/LP, a compact modular dynamic antivibration system offering isolation against all six translational and rotational vibrations.

<i>Isolation:</i>	dynamic 1Hz to 200 Hz, passive beyond 200 Hz.
<i>Transmissibility:</i>	see transmission curve. Above 10 Hz transmissibility <0.017 decreasing rapidly beyond 100 Hz, depending on load.
<i>Correction Forces:</i>	maximum 12N horizontally, 24N vertically
<i>System Noise:</i>	less than 50nG/ $\sqrt{\text{Hz}}$ from 0.1 - 200Hz in any direction
<i>Static Load:</i>	minimum 0kg maximum 600 kg on each element
<i>Static Compliance:</i>	approx. 1 $\mu\text{m}/\text{N}$ vertically, 2 $\mu\text{m}/\text{N}$ horizontally

### Control Unit

<i>Safety Class:</i>	1
<i>Power Consumption:</i>	typically 27W
<i>Input Voltage:</i>	90-125VAC / 200-250VAC, 50-60Hz
<i>Fuses:</i>	2 x 1.6A/250V slow. Located in the power socket on the rear side of the control unit.
<i>Overload Indication:</i>	24 LEDs indicate overload condition in output stage.
<i>Monitor Signal:</i>	A multiplexed signal for display on oscilloscope shows vibration levels with and without isolation.

### TOP

<i>Size:</i>	The units should be arranged parallel to each other and may be spaced any distance from each other provided that the top plate is sufficiently rigid. The width of the top plate should not be more than about 1.5 times the length of the isolation units.
<i>Material:</i>	Solid aluminium or granite 2-3cm thick or thick honeycomb material.



## Transmissibility

Vertical

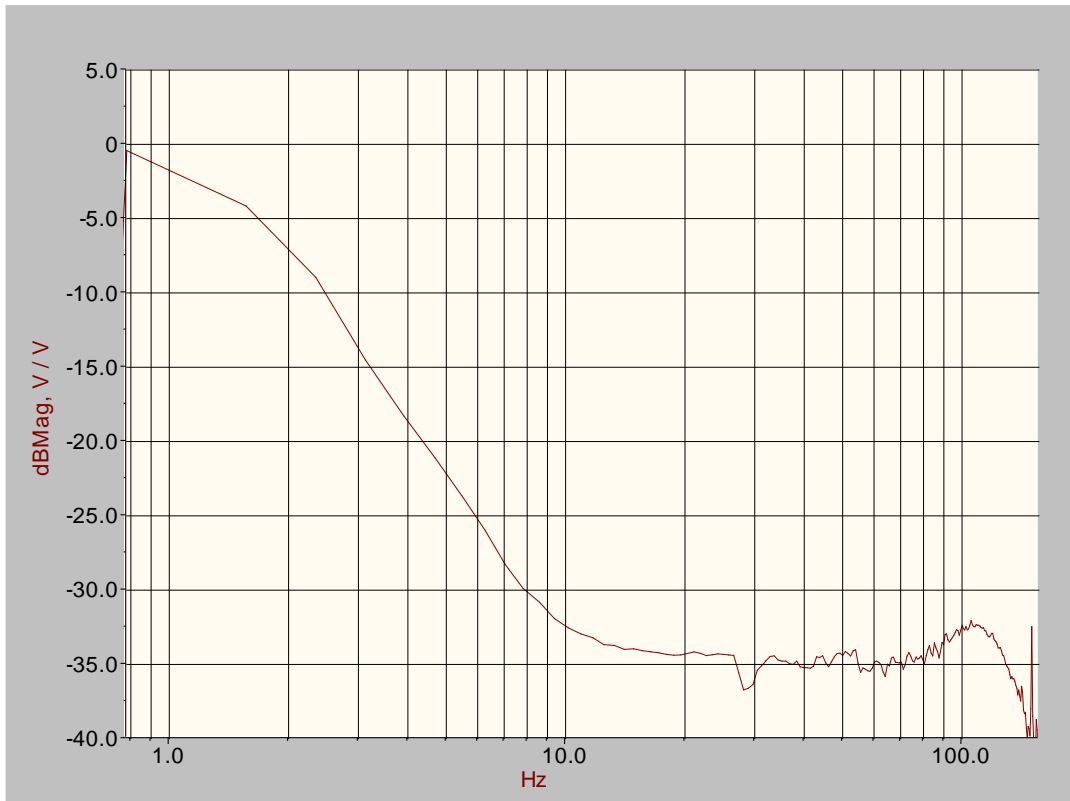

Horizontal

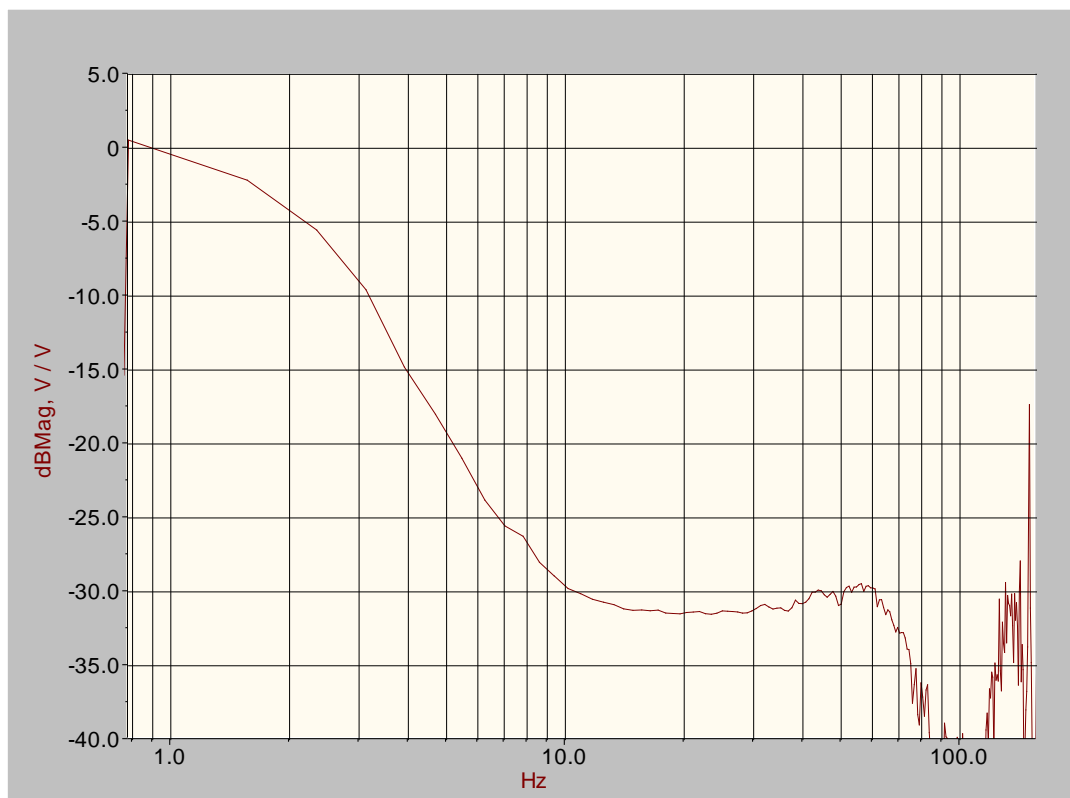

## Dimension AVI-600M/LP

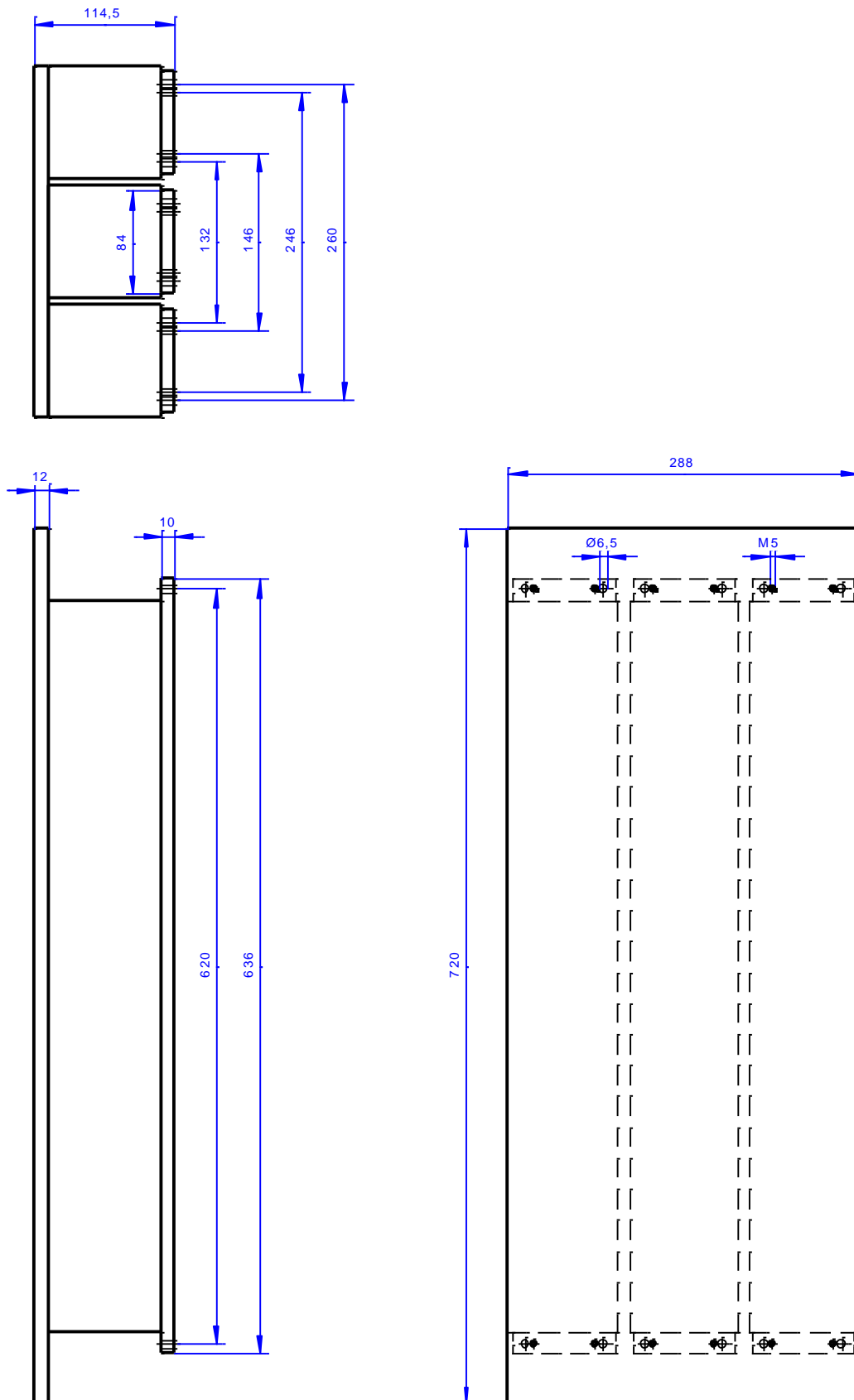





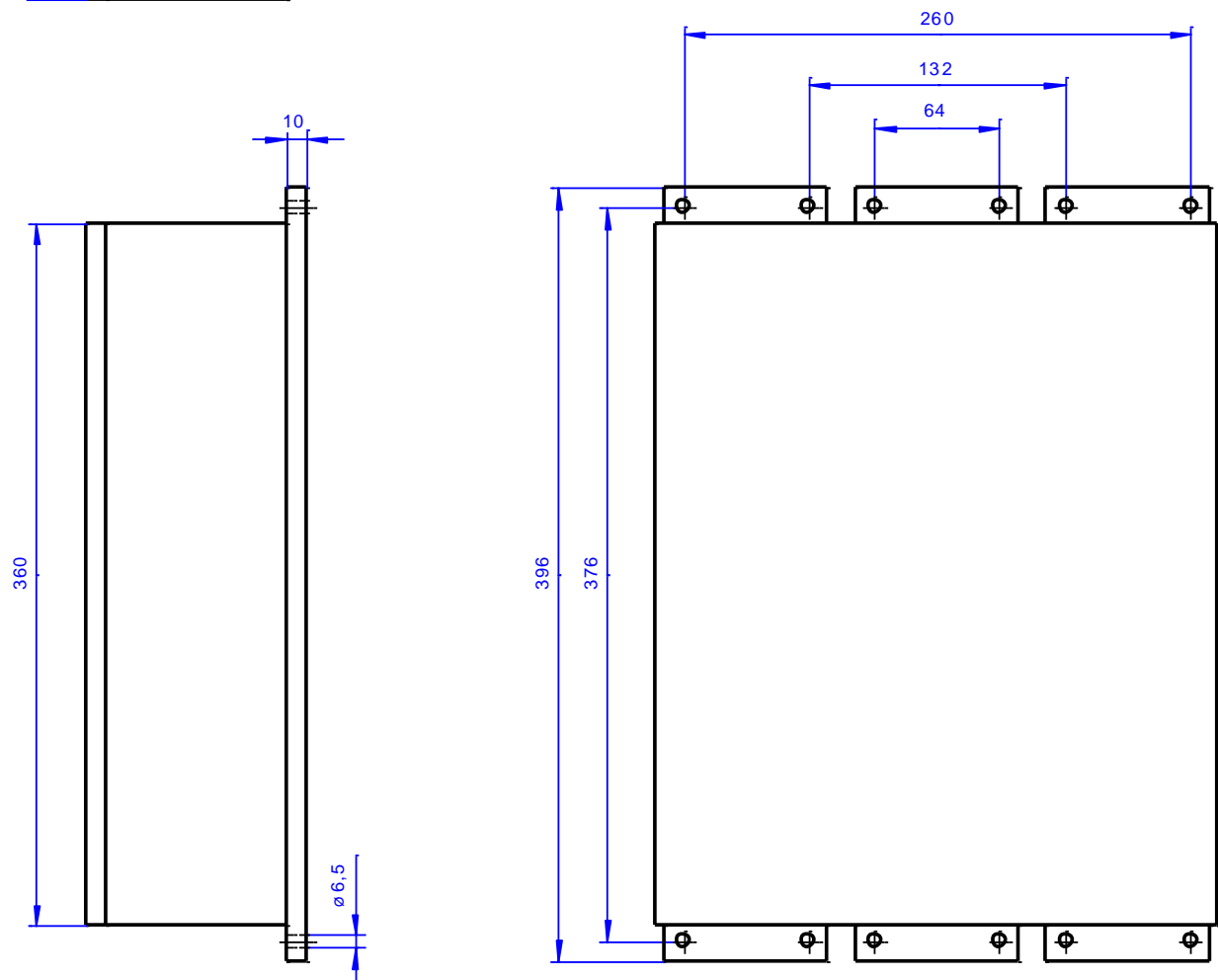
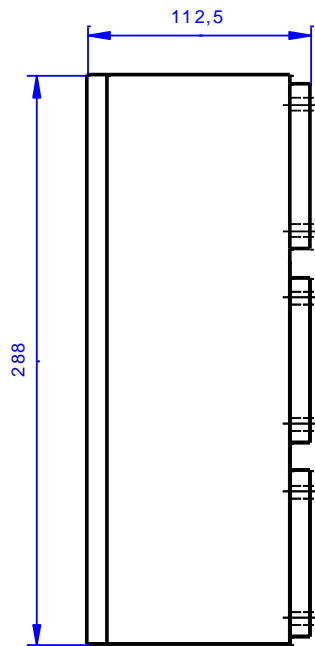

## Dimension AVI-600S/LP





## Sales Offices

<p><b>Geographical Europe, near and middle East, Africa, India:</b></p>		<p>Georgstrasse 11, 72119 Ammerbuch, <b>Germany</b> Phone: +49-7073-916796 Fax: +49-7073-916798 e-mail: <a href="mailto:hwl@hwlsscientific.com">hwl@hwlsscientific.com</a> Internet: <a href="http://www.hwlsscientific.com">www.hwlsscientific.com</a></p>
<p><b>Americas, Australia, New Zealand:</b></p>		<p>23042 Alcalde Dr. Suite E Laguna Hills, CA 92653 <b>USA</b> Phone: 949-363-2905 Fax: 949-340-9751 e-mail: <a href="mailto:sales@herzan.com">sales@herzan.com</a> Internet: <a href="http://www.herzan.com">www.herzan.com</a></p>
<p><b>Asia:</b></p>		<p>18/F., Yokohama Creation Square Bldg.,5-1, Sakaecho, Kanagawa-Ku Yokohama Kanagawa 221-0052 <b>Japan</b> Phone: +81-45-450-2211 FAX: +81-45-450-2221 e-mail: <a href="mailto:sales@herz-f.co.jp">sales@herz-f.co.jp</a> Internet: <a href="http://www.herz-f.co.jp">www.herz-f.co.jp</a></p>
<p><b>ASEAN countries and China (including Hong Kong)</b></p>		<p>83 Bukit Drive, #05-07 <b>Singapore</b> 587849 Phone: +65 96181 268 e-mail: <a href="mailto:enquiry@octalab.com">enquiry@octalab.com</a> Internet: <a href="http://www.octalab.com">www.octalab.com</a></p>