

LOW FREQUENCY SENSOR LFS-2

Instruction manual

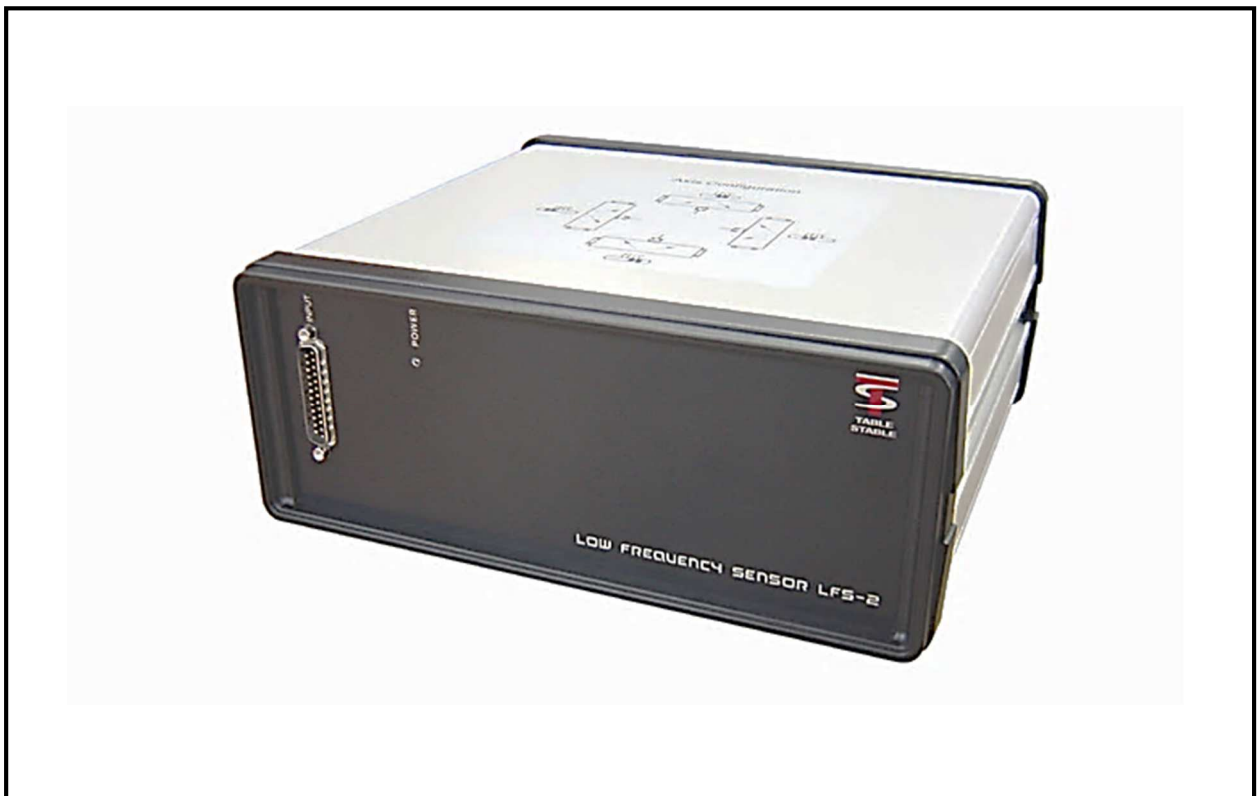

Address:
Im Grindel 6
8932 Mettmenstetten
Switzerland

Phone: +41 (0)44 776 33 66
Fax: +41 (0)44 776 33 65
E-Mail: info@tablestable.com
Internet: www.tablestable.com



Table of Contents

<i>Safety Instructions</i>	4
<i>Notes on equipment safety</i>	4
<i>Introduction</i>	5
<i>Connecting the sensor to an AVI/ system</i>	6
<i>Orientation of the AVI units and the Sensor</i>	6
<i>Operation</i>	7
<i>Setup Instructions</i>	9
<i>Specifications</i>	11
<i>Sales Offices</i>	11



Safety Instructions

The system may only be plugged into a socket with separate ground. Do not disconnect this ground, either at the socket, or by using an ungrounded extension cable.

If you suspect the system to be in any way unsafe, unplug and prevent any possible accidental usage. Contact your nearest service centre.

Before switching on this apparatus make sure that it is connected to the correct mains voltage. Do not remove any cover or allow any metal objects to enter the ventilation slits.

Disconnect from mains before removing any covers. Refer servicing to qualified personnel.

Do not use in potentially explosive surroundings.

Make sure the ventilation slits in the power unit are not covered and that air can freely circulate. Blocking the slits can lead to overheating which could cause a fire.

For indoor use only.

Notes on equipment safety

The LFS-2 has been designed, manufactured and tested to conform to the safety regulations for measurement- and control-equipment DIN EN 61010-1 (IEC 1010-1) and satisfies the relevant requirements of EEC Directive 73/23.

The system conforms to EEC Directive 89/336 (electro-magnetic compatibility).
The operator should read this manual which contains important warnings and information.

Cleaning the outside of the System

Use neutral detergents. Cleaning with solvents will damage the outside surface of the units. Do not use cleaning materials that contain ammonia.
Do not use isopropyl alcohol to remove dirt from the control panel. It may crack the panel.
Do not use flammable substances or any type of spray to clean the system.

Accessories

- 1 Power supply LFS-2/PS
- 1 Power cable
- 1 D-Sub 25 cable for sensor power
- 2...12 D-Sub 15 cables for connecting the AVI units to the sensor
- 1 Manual



Introduction

The LFS-2 sensor measures horizontal accelerations in two axes down to frequencies of about 0.2Hz. The sensor is placed directly on the floor and is used in a feed forward loop in combination with standard AVI/LP systems to increase the vibration isolation at very low frequencies. The LFS-2 can be retro-fitted to existing AVI-LP systems.

The table below shows the horizontal isolation (transmissibility) measured on an AVI/LP system with and without the LFS.

Frequency [Hz]	LFS[db]	AVI [dB]	AVI+LFS [dB]
6	-17.1	-35.3	-52.4
5	-15.9	-27.9	-43.8
4	-16.5	-22.5	-39.0
3	-17.0	-16.9	-33.9
2	-19.2	-8.9	-28.1
1	-15.6	-1.2	-16.8
0.7	-8.2	+3.3	-4.9
0.5	0	+3.5	+3.5

Measurements made with low frequency modified AVI-200S/LP with gain set at 150 (V) and 170 (H)

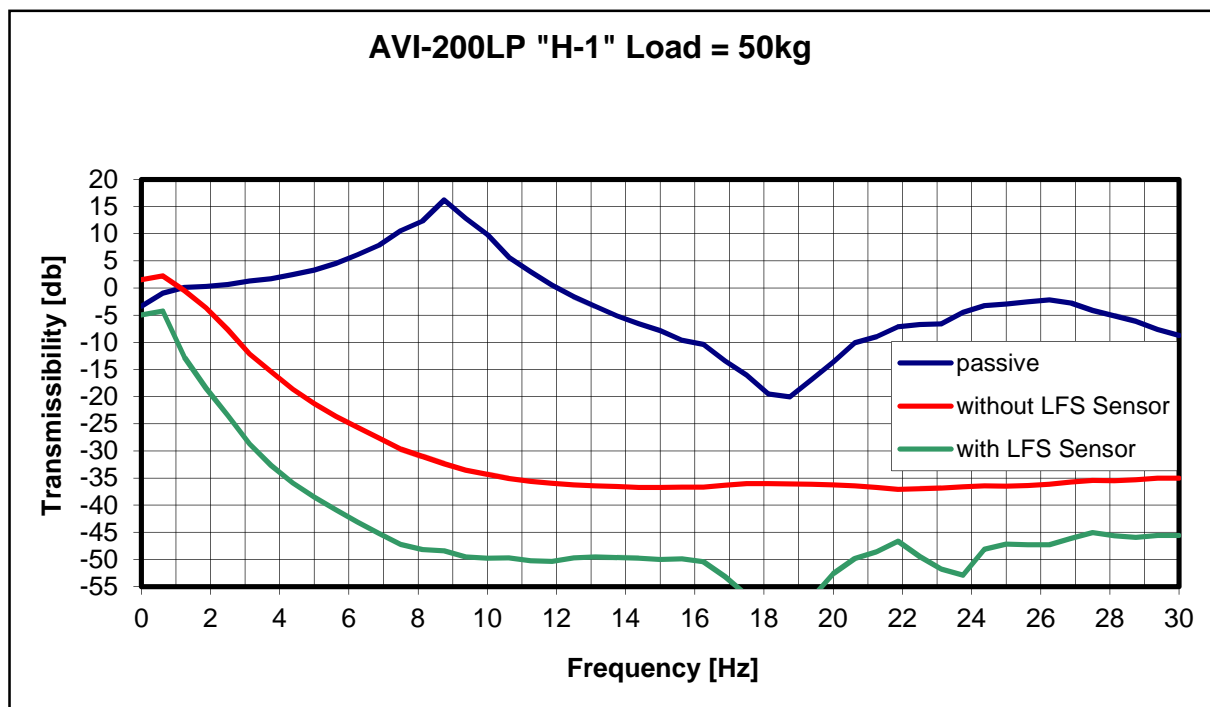

Connecting the sensor to an AVI/ system

The sensor LFS-2 has a separate power supply which is connected via a D-Sub25 socket to the LFS-2 control unit. **Connect the power supply to the sensor with a D-Sub 25 cable.**

Each individual AVI element must be connected to one of the D-Sub15 sockets on the rear of the sensor. The actual position of the LFS is not critical, but it must of course be placed on the **same surface** that supports the AVI units.

Connect the upper D-Sub 15 socket of the AVI unit to the sensor.

Orientation of the AVI units and the Sensor



It is important that the isolation units and the LFS sensor have the right orientation!

Each D-Sub15 socket on the LFS control unit has 4 switched outputs corresponding to AVI elements placed in any 4 rectangular orientations, i.e. **parallel** or at **right angles**. **Other orientations are not allowed.**

To ensure that the connections are correct proceed as follows:

Stand facing the blue LED of the LFS sensor. Connect the first AVI element to any one of the 12 D-Sub15 sockets on the rear panel.

Use a pen to slide the switch between position A and D



All AVI elements must be connected to a socket on the LFS unit. The correct switched position is absolutely essential for obtaining good isolation.

Parallel left

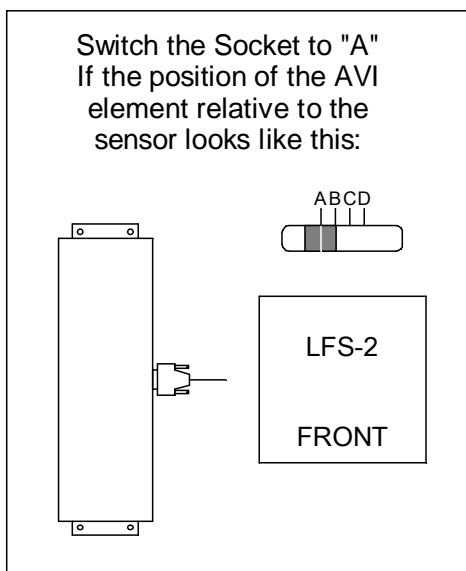

Parallel right

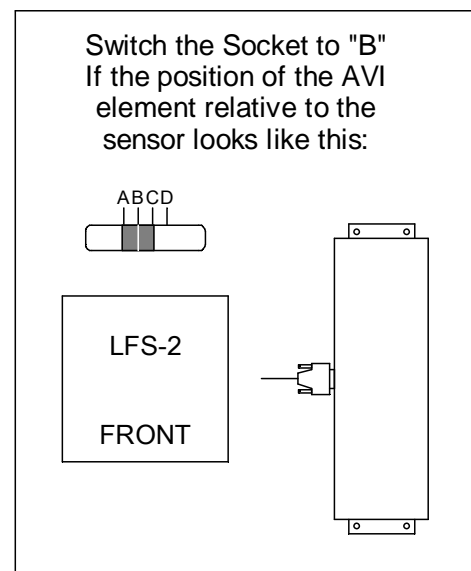

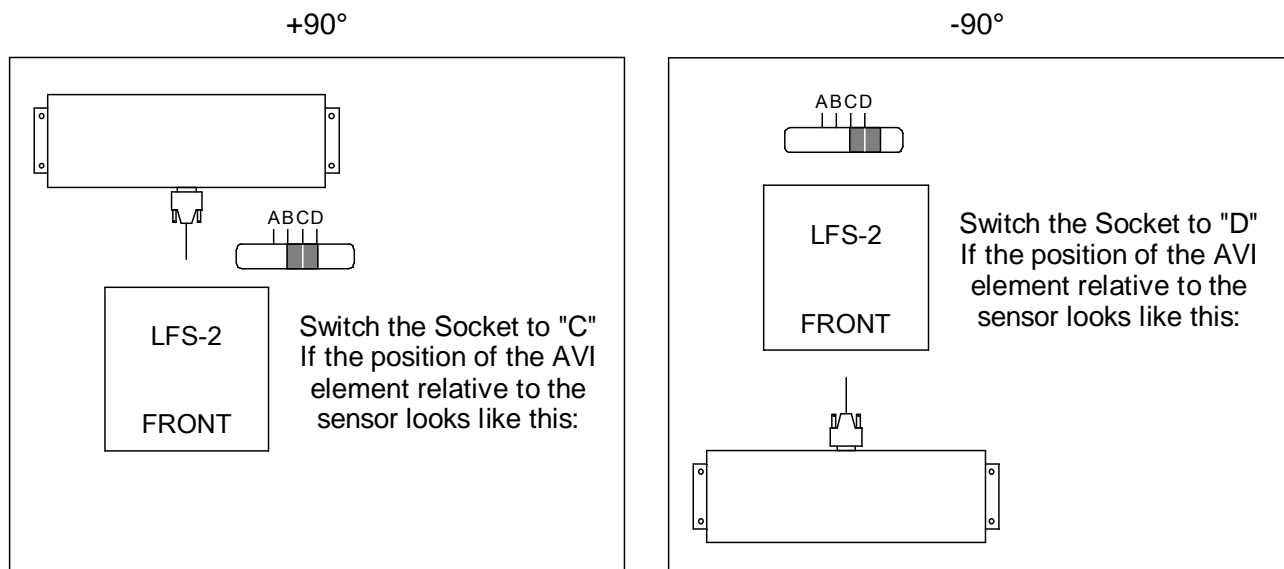

Position of the sensor

The sensor may be moved to any desired position. It may lie underneath the load or outside but must lie **on the same surface that supports the AVI elements**. After making the connections the orientation of the sensor to the AVI units must stay the same.

Rigidity of the support surface

The rigidity of the support surface is important. A horizontal sensor cannot distinguish between a horizontal acceleration and a tilt. The support surface on which the LFS and the AVI elements lie must therefore be as rigid as possible so that it does not tilt appreciably when people are moving in the neighbourhood. A tilt will cause the sensor output to saturate and the isolation will be lost.

Operation

After setup and connecting the power supply to the sensor the system is ready to use.

Switch on the power by pushing the power knob on the power supply. The green LED will light up. The red LEDs start to flicker that means there are some vibrations present. Now you can enable the system by pushing the enable button. The red LEDs should not light up anymore. If they light up that means the system is overloaded and the vibrations present in the building are too severe.



Note that the LFS will have no effect if it is not enabled.



Sensitive sensor unit, do not hit, knock or drop!

Power supply front

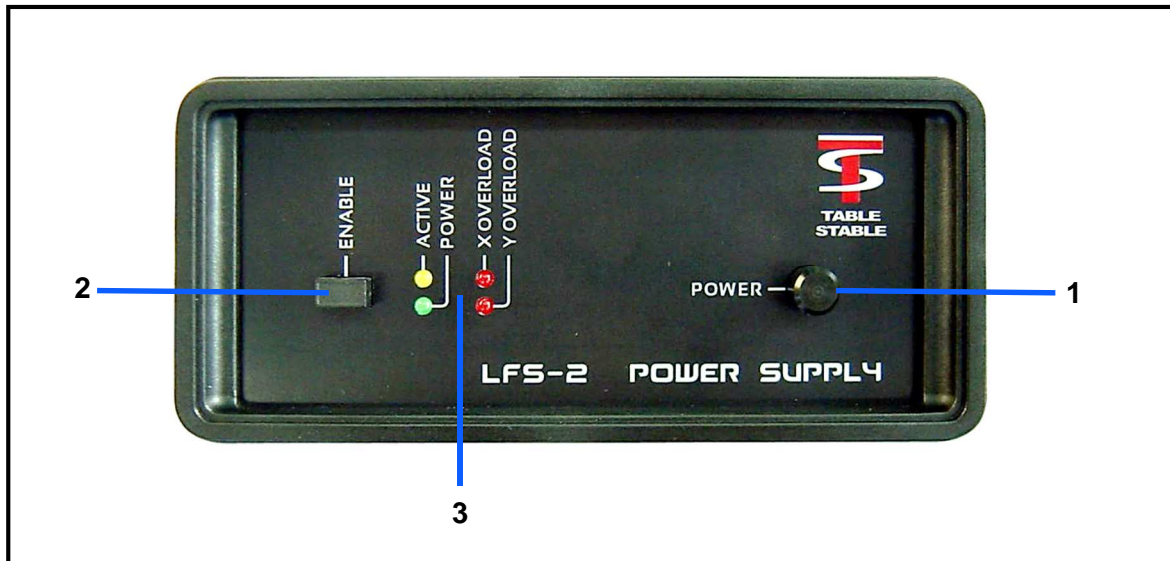

Power supply rear

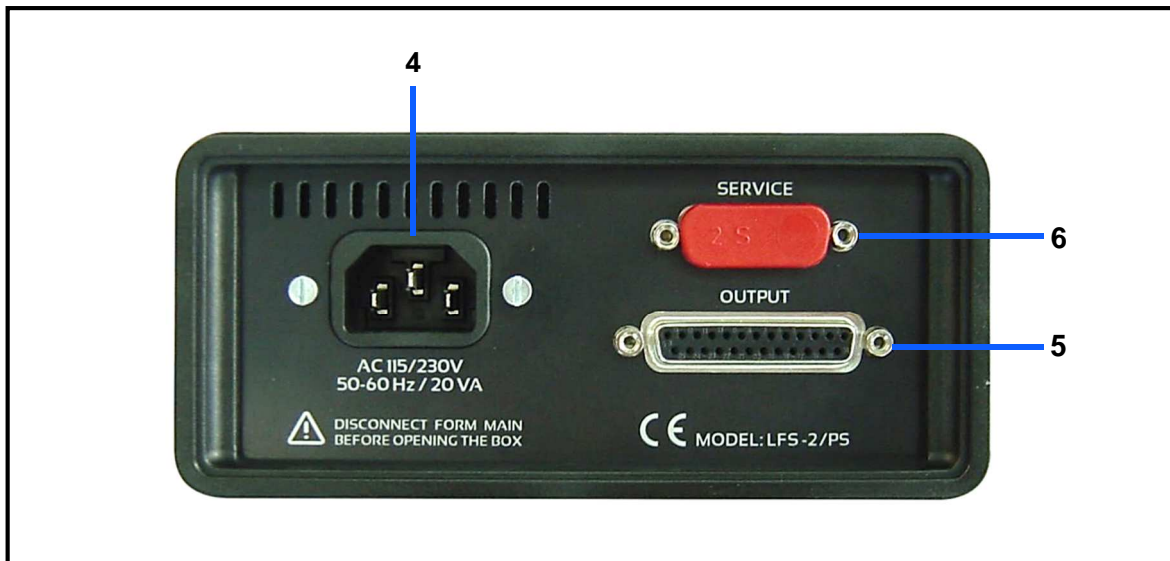

- 1 Power switch
- 2 Enable button
- 3 Status and overload indicators
- 4 AC power Input socket
- 5 Power output to LFS sensor
- 6 Socket for service and diagnostic (Factory use only)

Setup Instructions

LFS Sensor rear panel

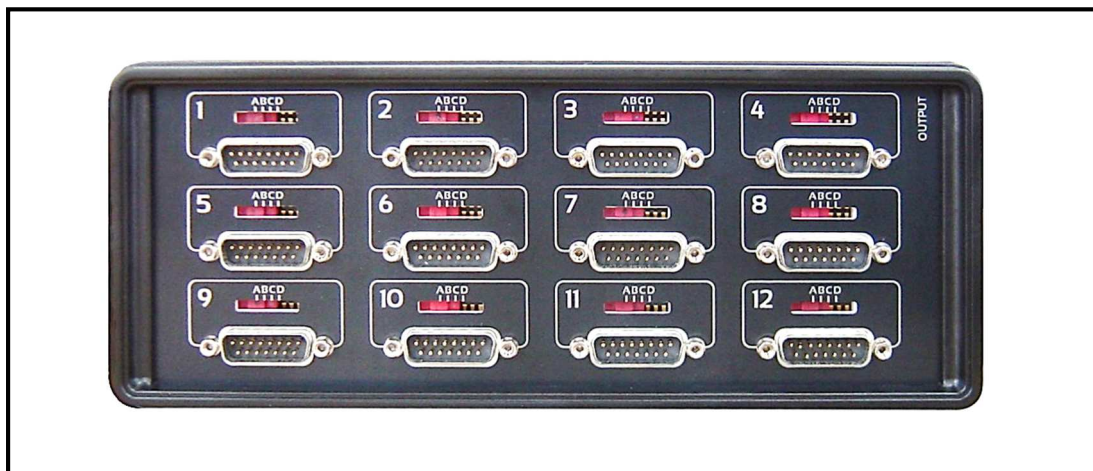

Connect the AVI units to any socket of the sensor rear panel.

Setup for AVI-200 and AVI-200/4

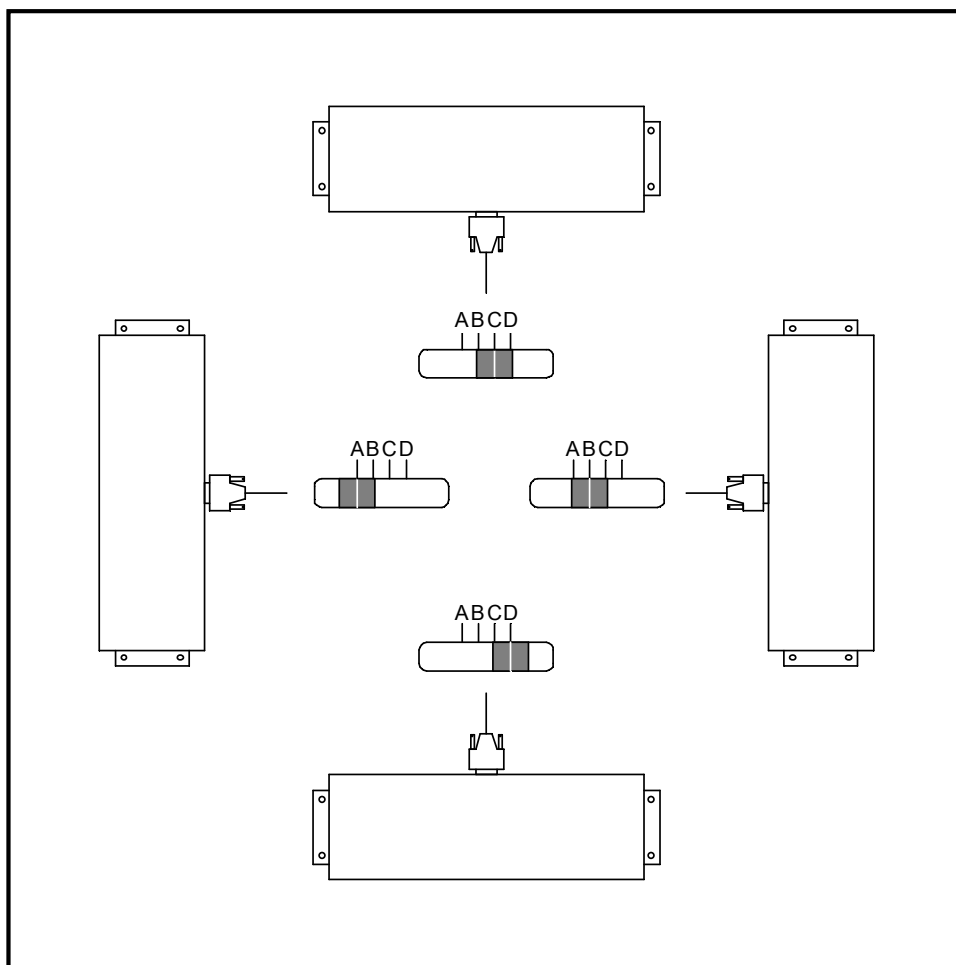

Setup for AVI-400 and AVI-400/4

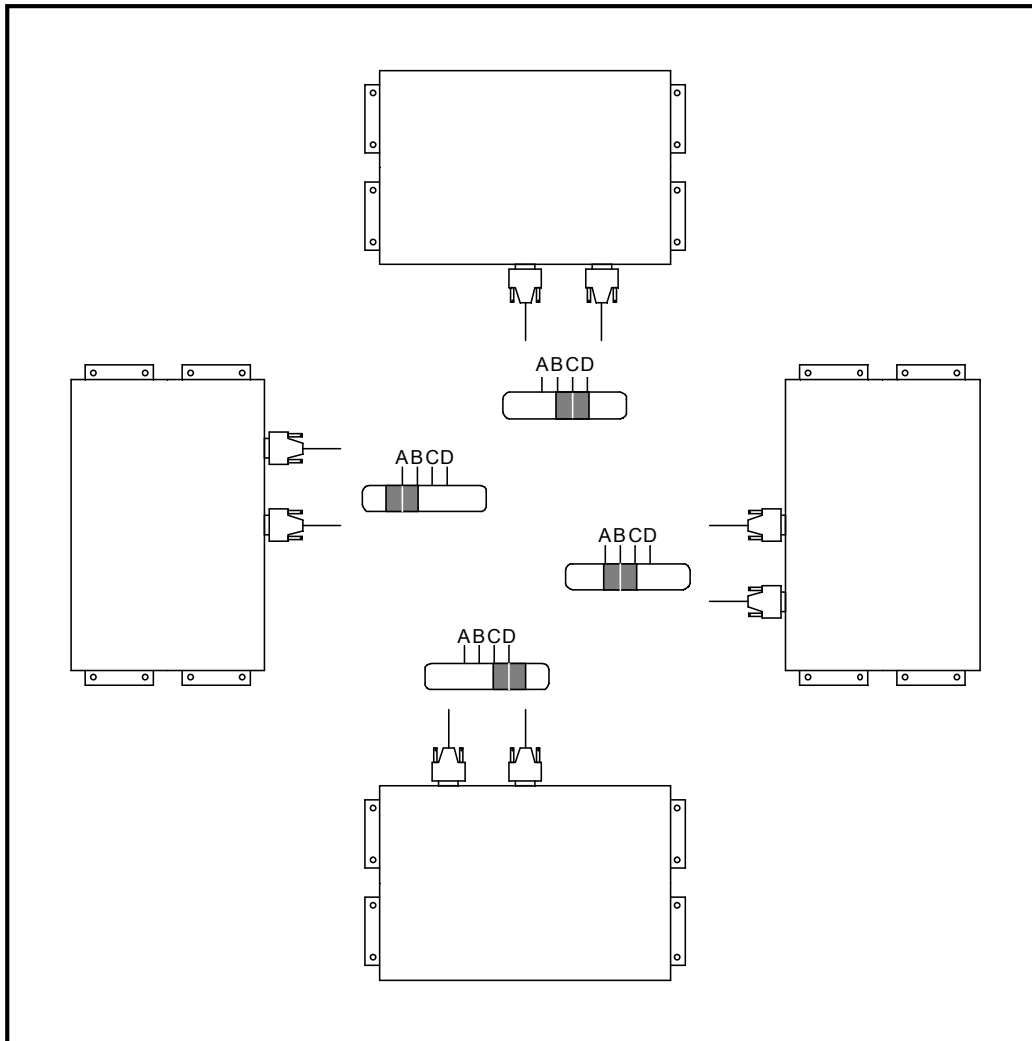

Setup for AVI-600

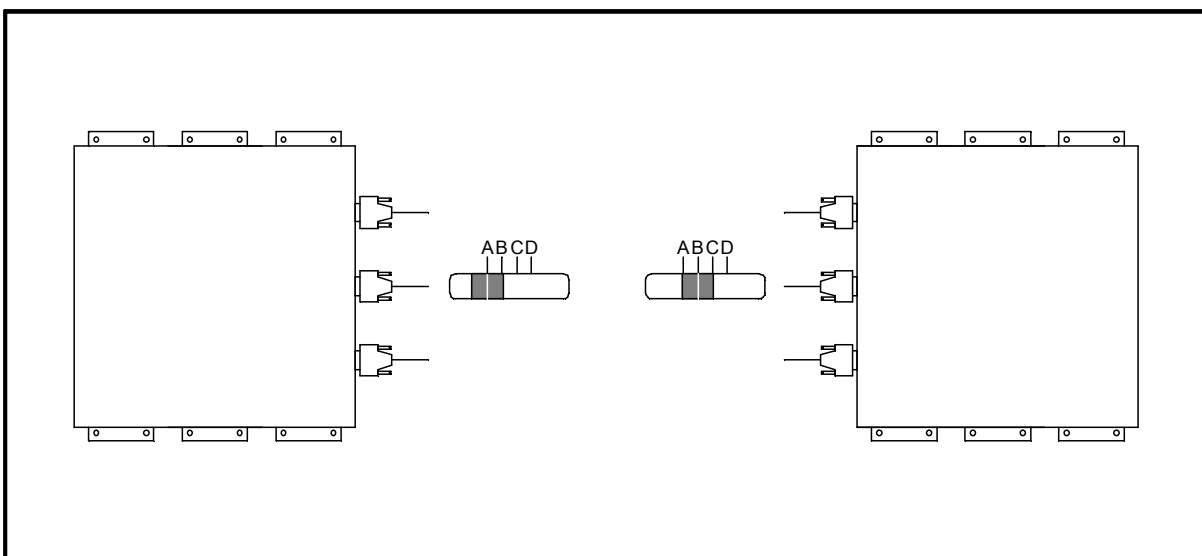





Specifications

Input Voltage:	115/230 V AC,	50-60Hz
Power consumption:	20 W maximum	
Frequency range:	0.2-20 Hz	
Dimensions Sensor:	255x245x107mm	(LxBxH)
Dimensions Power Supply:	265x155x73mm	(LxBxH)
Weight Sensor:	5.4 kg	
Weight Power Supply:	1.6 kg	

Application:	Indoor
Protection class:	IP 20
Temperature range:	5°C - 40°C
Relative humidity:	10 – 90% (5 – 30°C) 10 – 60% (30 – 40°C)

Sales Offices

<p>Geographical Europe, near and middle East, Africa, India:</p>		<p>Derendingerstrasse 40, 72072 Tübingen Germany Phone: +49-7071-54-99 863 Fax: +49-7071-54-98-821 e-mail: hw@hwscientific.com Internet: www.hwscientific.com</p>
<p>Americas, Australia, New Zealand:</p>		<p>23151 Alcalde Dr. Unit B-3 Laguna Hills, Ca 92653 USA Phone: 949-363-2905 Fax: 949-340-9751 e-mail: sales@herzan.com Internet: www.herzan.com</p>
<p>Asia:</p>		<p>18/F., Yokohama Creation Square Bldg.,5-1, Sakaecho, Kanagawa-Ku Yokohama Kanagawa 221-0052 Japan Phone: +81-45-450-2211 FAX: +81-45-450-2221 e-mail: sales@herz-f.co.jp Internet: www.herz-f.co.jp</p>
<p>ASEAN countries and China (including Hong Kong)</p>		<p>83 Bukit Drive, #05-07 Singapore 587849 Phone: +65 96181 268 e-mail: enquiry@octalab.com Internet: www.octalab.com</p>